

1.5625 mm Pixel Pitch with SMD LEDs

# A136-15-OB

All-in-one LED Display

A modular system for indoor applications



**Operation Manual**

**2021.08**

**Document version 1.00**



## **WARNING**

TO REDUCE THE RISK OF ELECTRIC SHOCK, DO NOT OPEN THE PANEL ACCESSIBLE DOORS WHEN POWER IS ON.

- Always ensure that the unit is properly earthed and power connections correctly made
- This equipment must be supplied from a power system providing a PROTECTIVE EARTH connection and having a neutral connection, which can be reliably identified
- The power outlet supplying power to the unit should be close to the unit and easily accessible
- Always remember to close and lock the panel access doors after servicing and before resuming the power supply
- Ensure whole system power off before connect or disconnect the net cable
- Always remember to dry the panel fully before packing
- Store in a dry and airy place
- Suggest using below method to cleaning the Intelligent Modules (IM): Using electrostatic-proof soft-brush to clean the IM per month to keep the LEDs clean. Clean with solvents is not allowed.
- The picture in the manual just for reference, the actual subject to shipment product.
- Electrostatic discharge may harm the surface of the LED units. To prevent such damage, you should discharge static electricity from your body before you contact with the LED units.
- The product must be installed in an environment out of human reach. If a person touches the product, its performance may deteriorate. If the product needs to be installed in a place where human contact with the product is likely, a separate measure to prevent people from touching it needs to be taken.
- [Caution to prevent damage to the LED from static] Do not touch the product without anti-static gloves.

**TABLE OF CONTENTS**

Section	Item	Page
<b>1</b>	<b>General</b> .....	<b>4</b>
1.1	Brief Description of Purpose and Operation of System .....	4
1.2	A136-15-OB LED Panel Specification .....	5
1.3	A136-15-OB LED Panel System Specification .....	6
<b>2</b>	<b>Main Assemblies</b> .....	<b>7</b>
2.1	A136-15-OB Panel Assembly .....	7
2.1.1	Component Placement .....	7
2.2	Intelligent Modules (IM).....	8
<b>3</b>	<b>Installation Guides</b> .....	<b>9</b>
3.1	Installation.....	9
3.1.1	Mounting Plate Installation .....	9
3.1.2	Screen Installation.....	13
3.2	Electrical.....	23
3.2.1	Circuit Protection.....	23
3.2.2	Earth Leakage Considerations.....	23
3.2.3	Inrush-current and Over-current Considerations.....	23
3.2.4	Earthing.....	23
3.2.5	EMC Statement.....	23
3.2.6	FCC Statement.....	23
3.3	Power Cable Wiring.....	24
3.3.1	AC Power.....	24
3.3.2	Number of Power Cords.....	24
3.3.3	DC Power.....	24
<b>4</b>	<b>Setting</b> .....	<b>25</b>
4.1	The Introduction of A136-15-OB Screen Interface and Function.....	25
4.1.1	Remote Controller.....	25
4.1.2	Interface Specifications.....	25
4.1.3	Connection.....	26
4.2	Parameter Settings.....	27
4.2.1	Set Up the Connection.....	27
4.2.2	Basic Setup.....	28
4.2.3	Parameter Settings.....	28
4.2.4	Video Source Settings.....	28
4.2.5	Others.....	30
4.2.6	Detect the Receiver Card.....	30
<b>Appendix A</b>	<b>Procedure for IM Replacement</b> .....	<b>31</b>
<b>Appendix B</b>	<b>Trouble Shooting Guide</b> .....	<b>31</b>
<b>Appendix C</b>	<b>A136-15-OB Mechanical Assembly</b> .....	<b>34</b>
<b>Appendix D</b>	<b>A136-15-OB Data Wiring Diagram</b> .....	<b>36</b>
<b>Appendix E</b>	<b>A136-15-OB Power Wiring Diagram</b> .....	<b>37</b>

## **I. General**

This manual provides an overview of the A136-15-OB LED display system, the main system components and interconnection methods. If any details in this document are unclear, please contact your local representative, or the head office for more details.

### **I.1 Brief Description of Purpose and Operation of System**

The A136-15-OB LED display system is designed for indoor use, where a high quality dynamic image is to be made visible to large numbers of people. The panel size is designed from the beginning according to end-user requirements.

## I.2 AI36-15-OB(12X6IM) LED Panel Specification

### I.5625mm Indoor SMD LED AIO Screen

Parameter	Unit	Value	
Brightness(typ*)	nits	800	
Color temperature	deg. K	6,500	
Visual viewing angle - Horizontal	deg.	160(+80/-80)	
Visual viewing angle - Vertical	deg.	160(+80/-80)	
Panel weight(max)	kg / lb	131/288.9	
weight(max)(sq.m)	kg / lb	25.7/56.7	
Display diagonal/ Panel diagonal	mm / ft	3448.3/11.31	3,442/11.29
Display width / Panel width	mm / ft	3004.6/9.86	3,000/9.84
Display height / Panel height	mm / ft	1692.1/5.55	1,687.5/5.54
Panel depth(min)	mm / ft	35.5/0.116	
Display area / Panel area	sq.m / sq.ft	5.1	54.5
Panel material		Aluminum	
Panel Color	/	Pantone Matte Black	
Aspect ratio		16:9	
Ingress protection(Front/rear)	IP	IP40/IP20	
Operating / storage temperature	deg. C	0 to +40 / -10 to 50	
Operating / storage humidity	%	< 90 (Without condensation)	
Pixel type and configuration	R/G/B	SMD 3 in 1	
Pixel pitch	mm	1.5625	
Pixel LED per Panel		1,920x1,080	
Pixel per Panel		2,073,600	
Pixel Lines per meter		640	
Pixel per sq. meter		409,600	
Recommended minimum viewing distance	m	1.5	
Colors		281 Trillion	
Grey scale (linear)	Levels	65,536 levels per color	
Brightness control	Levels	100	
Contrast ratio		3,000:1	
Processing depth	bit	16	
Video frame rate	Hertz	50/60	
Display refresh rate	Hertz	≥2880	
Input voltage (nominal)	VAC	100 to 240	
Input power frequency	Hertz	50 to 60	
Input power (max)	VA	3,000	
Lifetime (50% brightness)	Hours	≥100,000	
Panel input format		USB/HDMI	
Data interconnection		USB/HDMI	
Mounting system		Wall Mount, Stand with support	
Panel Maintenance		Front Access	
Certificate		CE, FCC, ETL, CB, RoHS2.0, REACH	

( DR )

\* Specification subjected to change without prior notice

\* The tolerance of brightness is ±3%

### I.3 A136-I5-OB LED Panel System Specification

<b>Control interface</b>	
<b>USB-B</b>	Display configuration interface
<b>Indicator light and Button</b>	
<b>Indicator light</b>	Standby light(red)
	Power light(green)
<b>Button (customizable)</b>	Brightness Keys (up, down button)
	Standby/Power On Button
<b>Other Ports</b>	
<b>USB3.0</b>	1xUSB3.0, supports Ultra-highspeed USB device
<b>USB2.0</b>	2xUSB2.0, supports external USB flash disk and other external expansion equipment
<b>Media Format</b>	
<b>Video Formats</b>	Common formats such as AVI, WMV, MPG, RM/RMVB, MOV, DAT, VOB, MP4, FLV and etc. Supports multiple videos play at the same time.
<b>Video Formats</b>	MPEG-I Layer III, AAC , etc.
<b>Image Formats</b>	bmp, jpg, png, etc.

## 2. Main Assemblies

### 2.1 A136-15-OB Panel Assembly

Each A136-15-OB LED panel comprises an outer cladding panel with integral aluminum framework for increased rigidity and a central stacker for the fast rigging. The panel is designed to be mounted to a fixed framework.

The listing in Table 2.1 is the main components of a A136-15-OB LED panel. The profile of the panel is shown in Figure 2.2.

Item	Description	Qty
1	Intelligent Modules (IM)	72
2	I/O Board	1
3	AIO controller Board	1
4	Power Board	1
5	IR Receiver Board	1
6	Power and Mini Card Convertor Board(2 in 1)	36
7	12V/200W Switched Mode Power Supply	1
8	3.8V/189W Switched Mode Power Supply	18
9	EMI / RFI AC power line filter	2

Note: The PSU output is adjustable, the actual value would subject to the label of manufacturing data

**Table 2.1 - Major components of A136-15-OB LED panel assembly**

#### 2.1.1 Component Placement

There are five kinds of system board worked for the LED display, IR Receiver Board, Power and Mini Card Convertor Board, I/O Board, AIO controller Board and Power Board. Please refer to the description for each board in the follow sections.

A136-15-OB LED display is combined with intelligent module and case. The intelligent modules and case are fixed by magnetic structure.

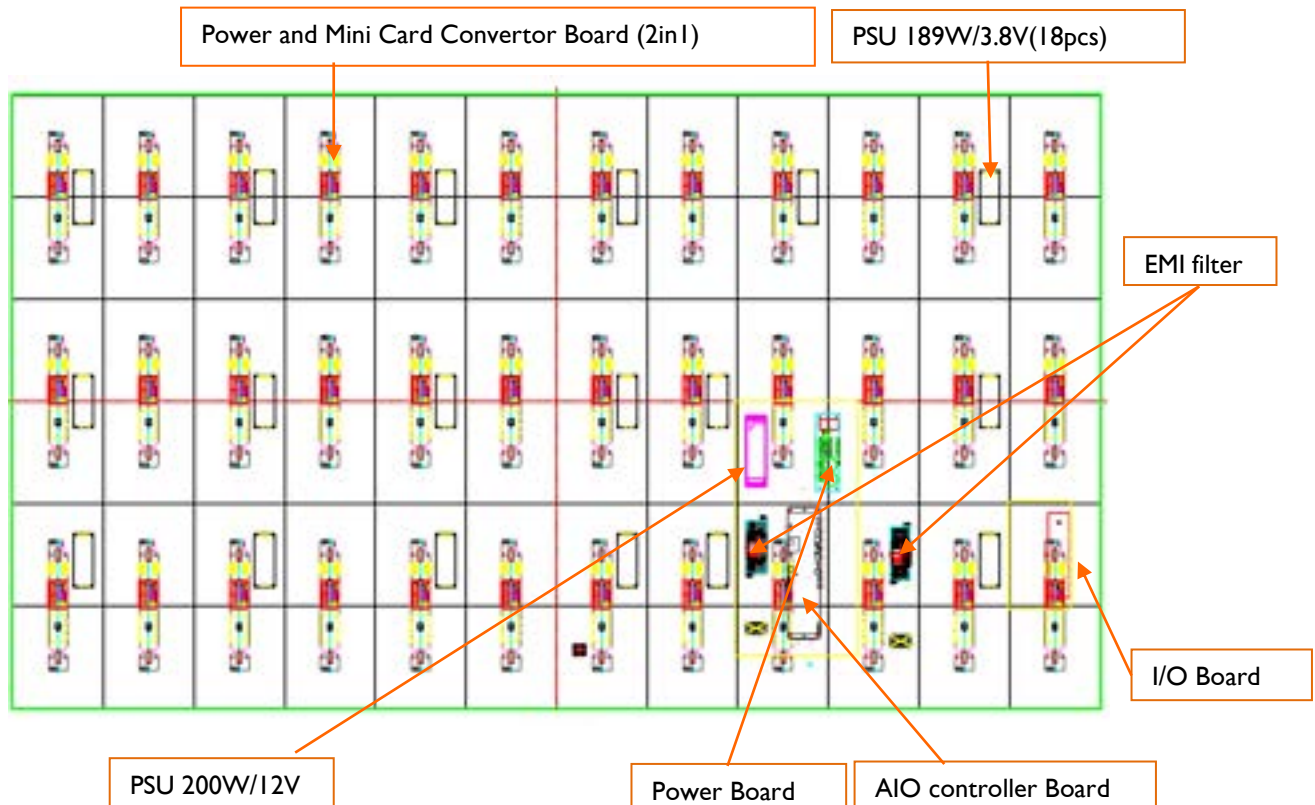

**Figure 2.1 Major components placement for A136-15-OB**

## 2.2 Intelligent Modules (IM)

The front face of the A136-15-OB LED display is fitted with 72 light emitting diode (LED) dot LED modules known as Intelligent Modules. Each intelligent module is fitted with 28880 LEDs\* plus associated drive electronics. Electrical connections (low voltage power, and digital data) are made to the rear of each intelligent module, from inside of the enclosure.

Figures 2 and 3 are showing the front and rear views of an A136-15-OB intelligent module.

\* Remark: each intelligent module contains 160x180 pixels (row x column) and each pixel is composed by 3 in 1 LEDs, so there are totally 28800 LEDs fitted on the front face of an intelligent module.



**Intelligent Modules - front view**



**Intelligent Module - rear view**



### 3. Installation Guidelines

**Please read the following carefully before installing the panels**

The A136-15-OB LED display, each intelligent module is equipped with 4 pcs guide pin, are fixed with magnetic structure and jointed together both vertically and horizontally, so that they can form one surface of screen-configuration.



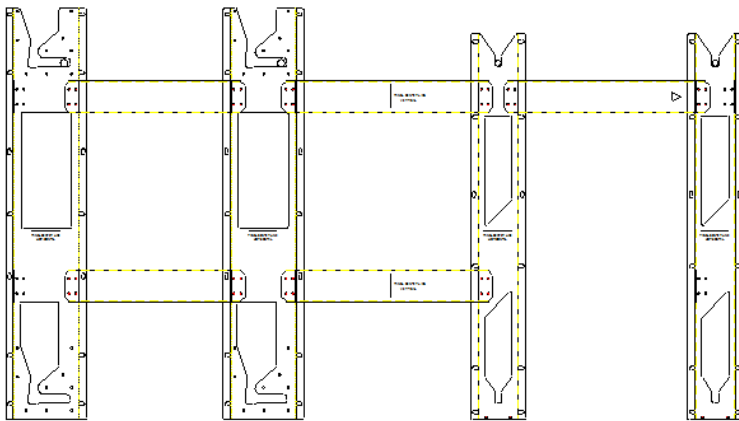

The A136-15-OB LED display is designed to be mounted on the stand (sold separately) or on the wall. When installing, it is important to ensure that the entire screen is correctly aligned, both vertically and horizontally.

#### 3.1 Installation

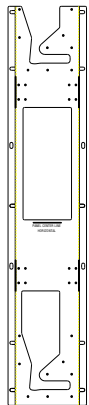
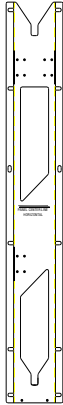

##### 3.1.1 Mounting Plate Installation

###### I. Wall mount piece list:

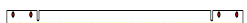
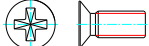
Item	Photo	Qty	Description	Item	Photo	Qty	Description
1		2	Left plate	2		2	Right plate
3		2	Left connection plate	4		2	Middle connection plate
5		1	Right connection plate	6		1	Bottom connection plate
7		44	Flat head screw M3X12				

**Step1. Install the left plate with connection plate .**

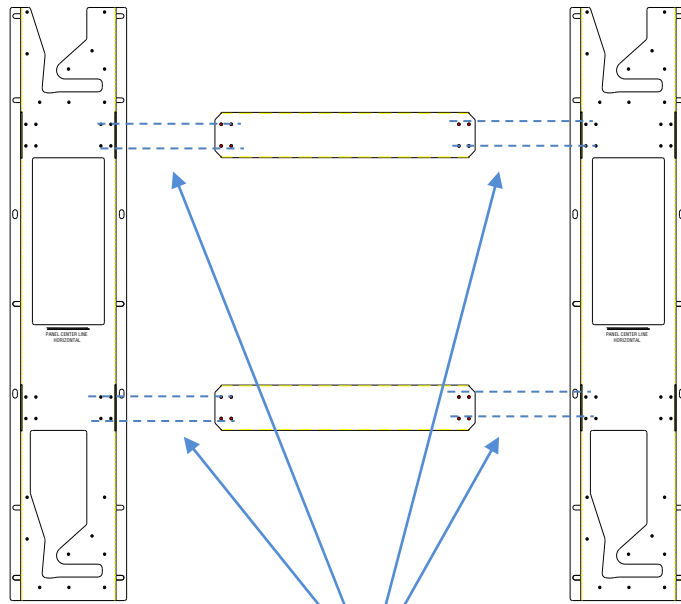

Use 16pcs M3X12 screw (item 7) to install the left plate (item1) with left connection plate(item3).

**Step2. Install the right plate with connection plate.**

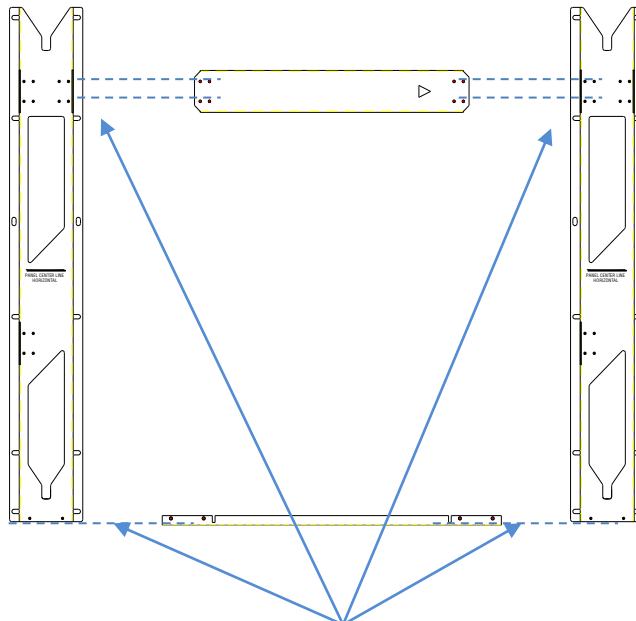

Use 12pcs M3X12 screw (item 7) to install the right plate (item2) with right connection plate and bottom connection plate(item5/item6).

**Step3. Connect the left assembly and right assembly by intermediate plate.**

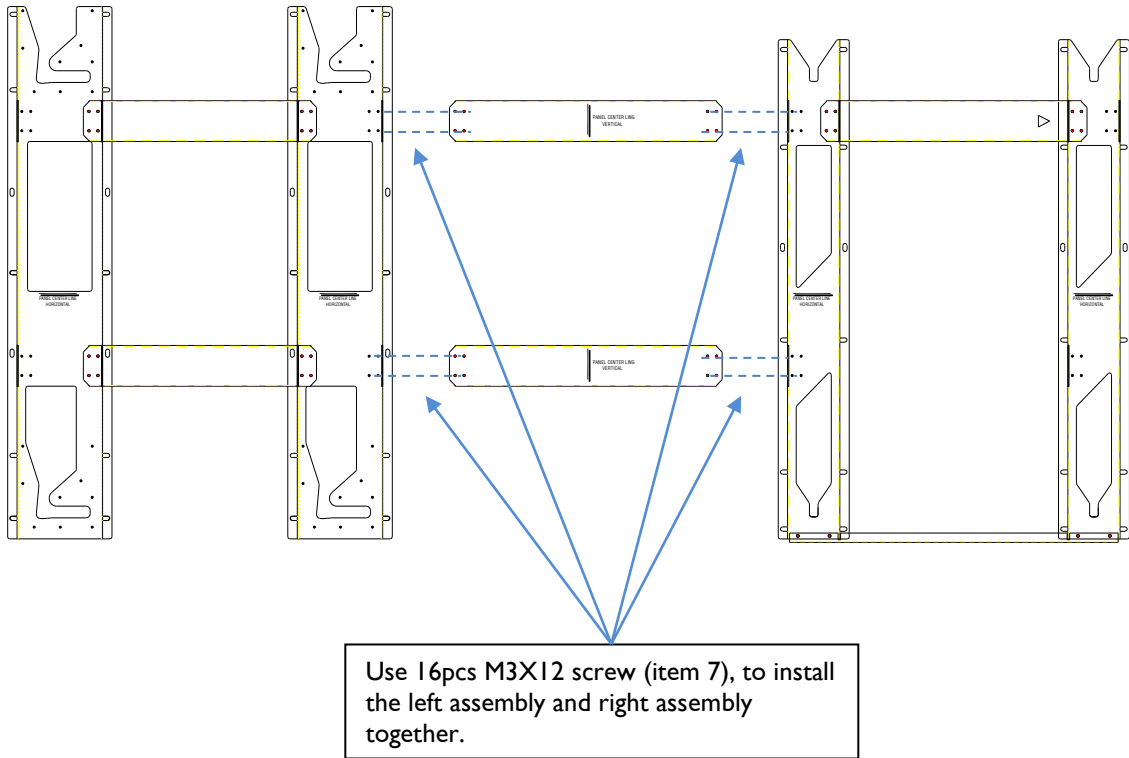

**Step4. Double check the dimension after assembling.**

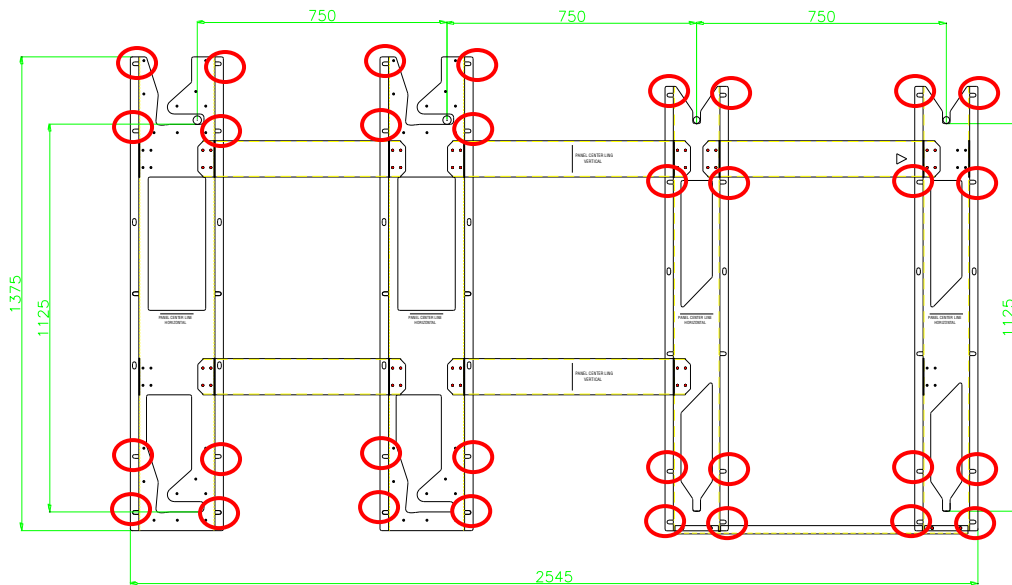

*It is suggested to fix the assemble frame of shelves completely according to the fixed points shown in the circle.*

**Step5. Remove the bottom connection plate after installation.**

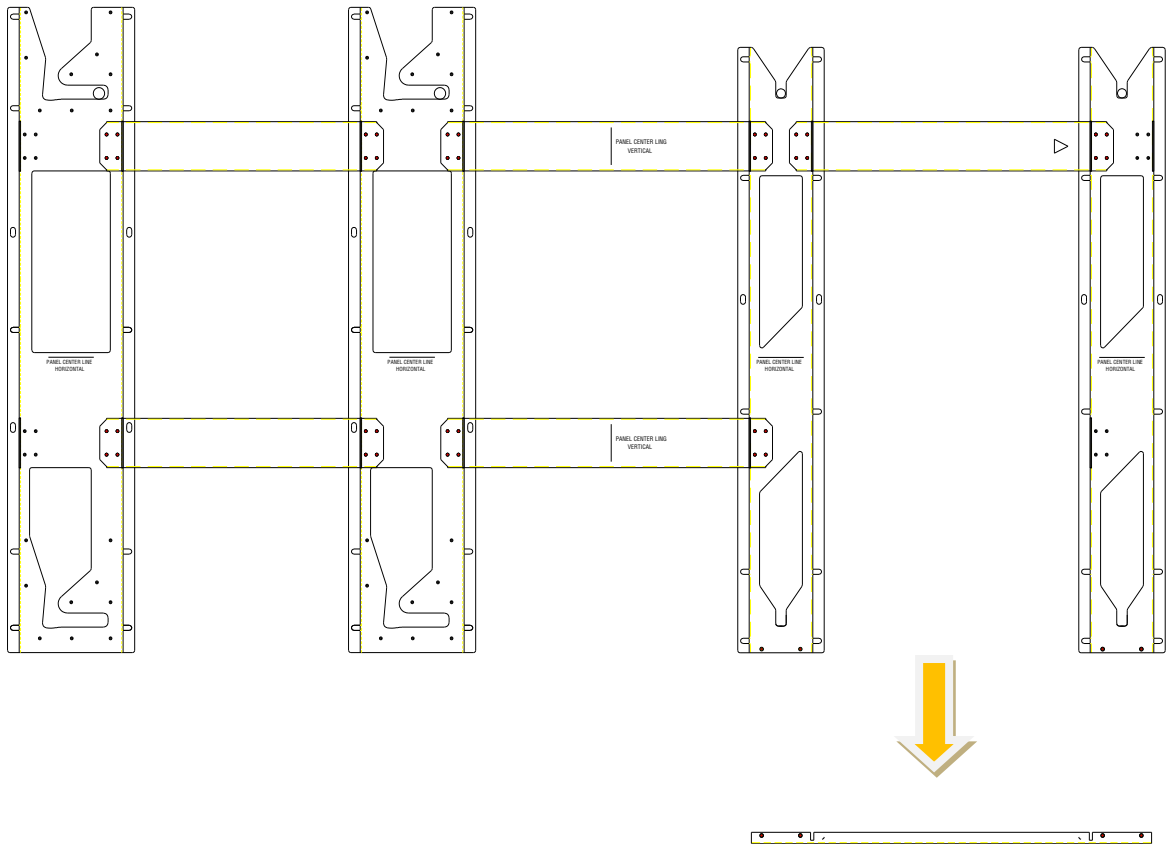

**2. Screen assembly**

- a. First, the 8 PCS fixed screw behind the box are assembled to the box and locked with tools.
- b. The following figure is marked in red.

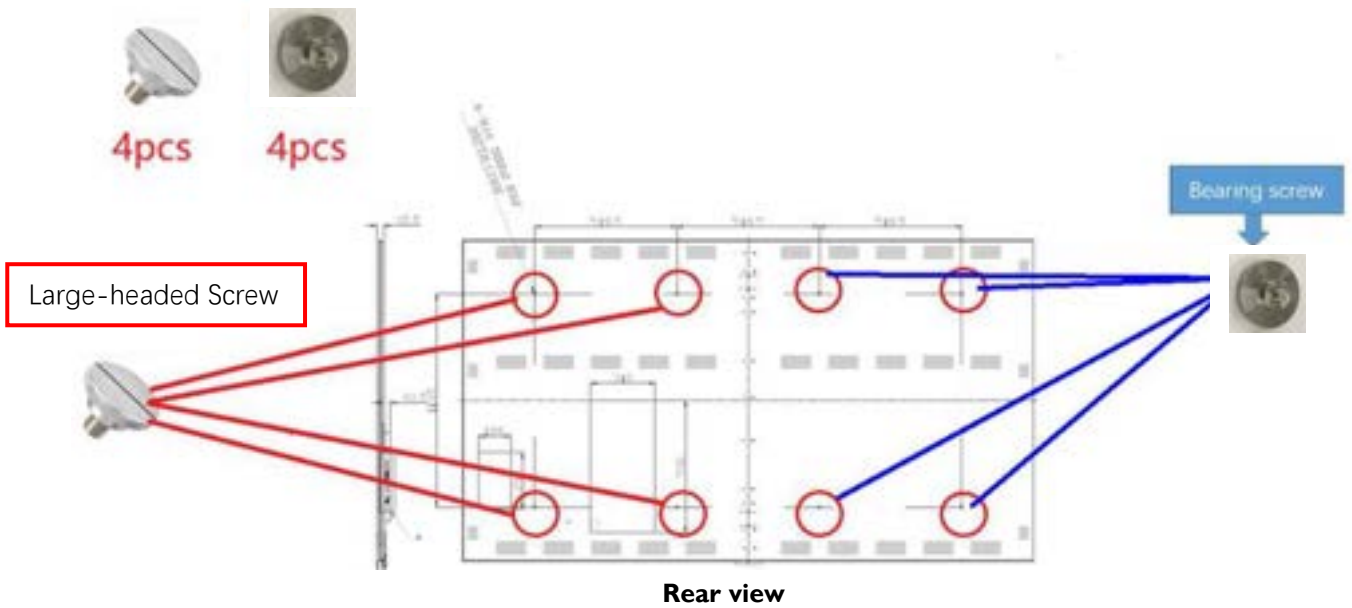

**3.1.2 Screen Installation**

**Brief installation diagram**

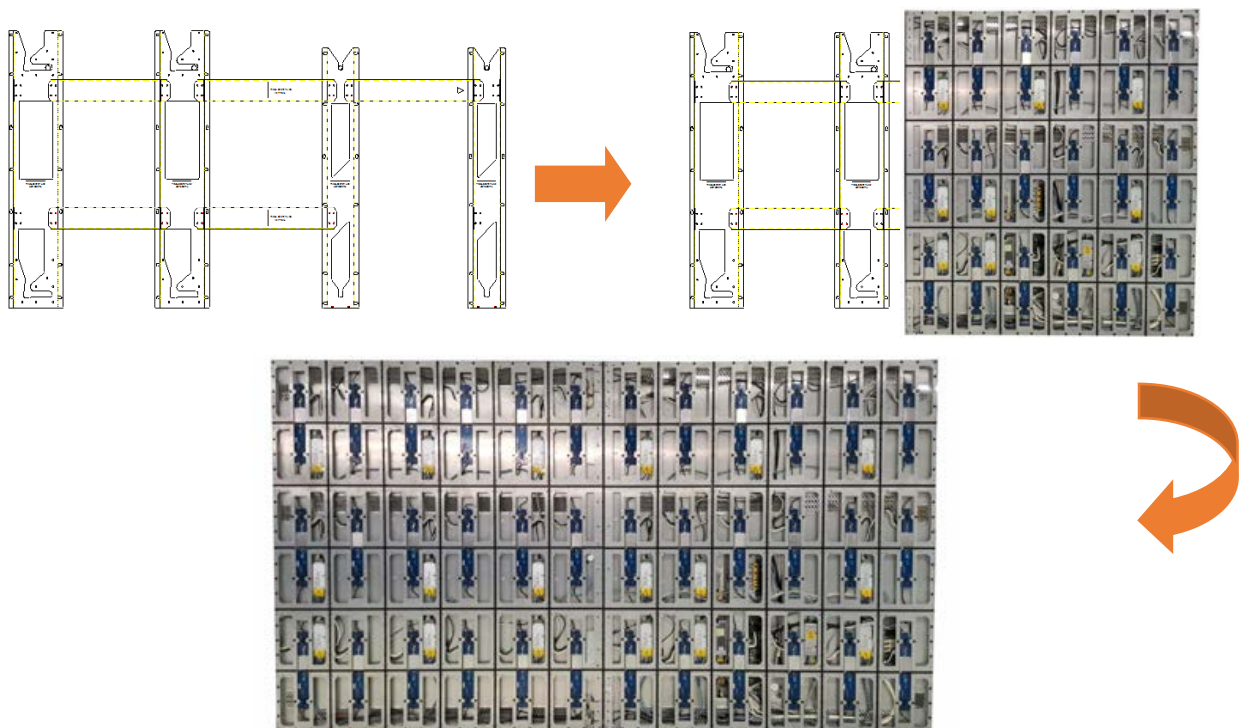

## Installation Guides

1. The two members jointly lifted the right half cabinet and placed it on the Stand's bracket.

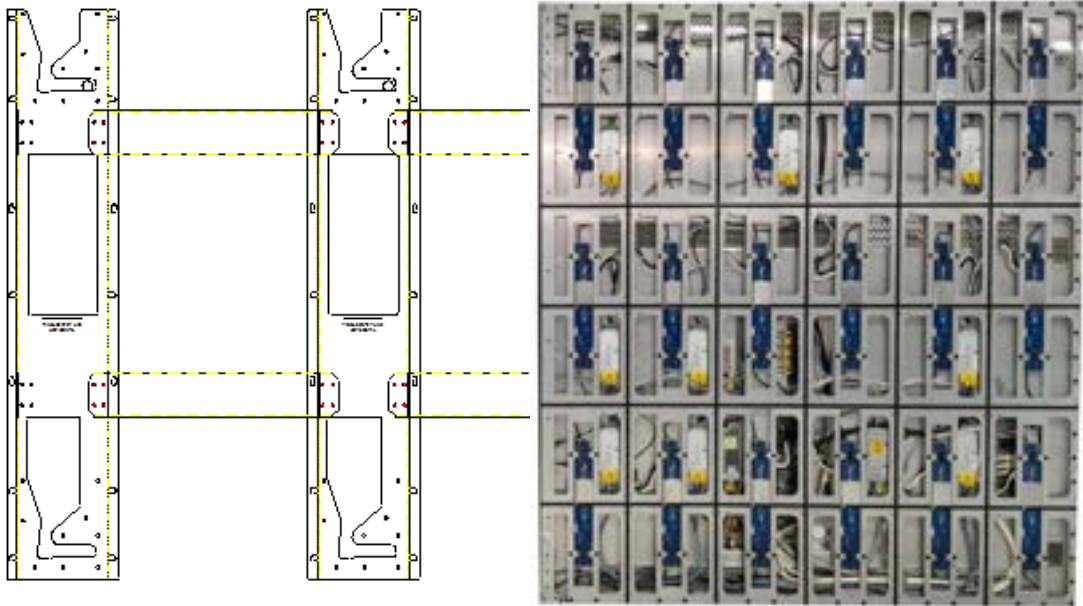

2. Place the left half cabinet on the bracket in order.



3. You need to connect all the cables and install back all the intelligent modules.

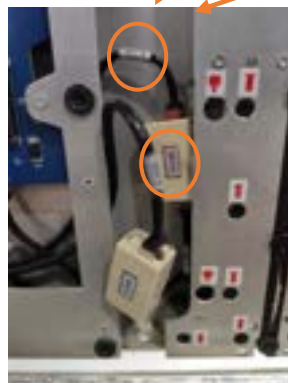
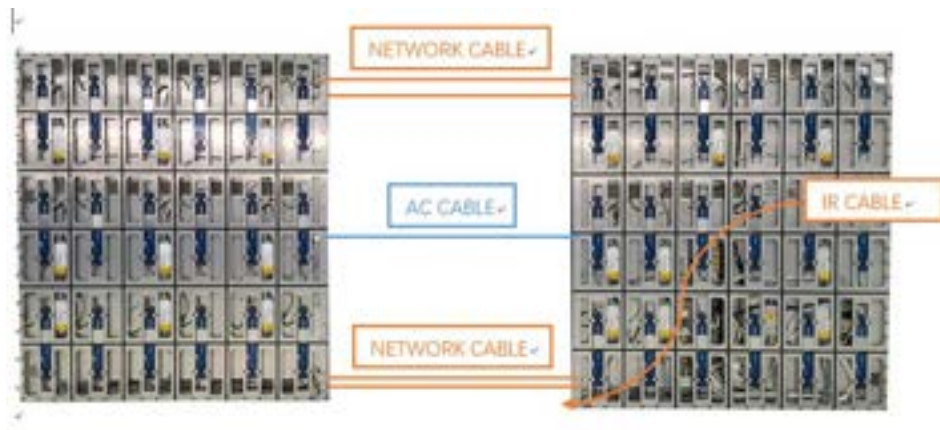

**NETWORK CABLE(4PCS)**  
Please pay attention to the labels, eg. RJ45 cable labelled OUT1 is matched to the connector labelled OUT1.



**AC CABLE(1PC)**

4. The cabinet is combined by sliding on the wall mount, we must make sure that the steel block is properly connected to the positioning.

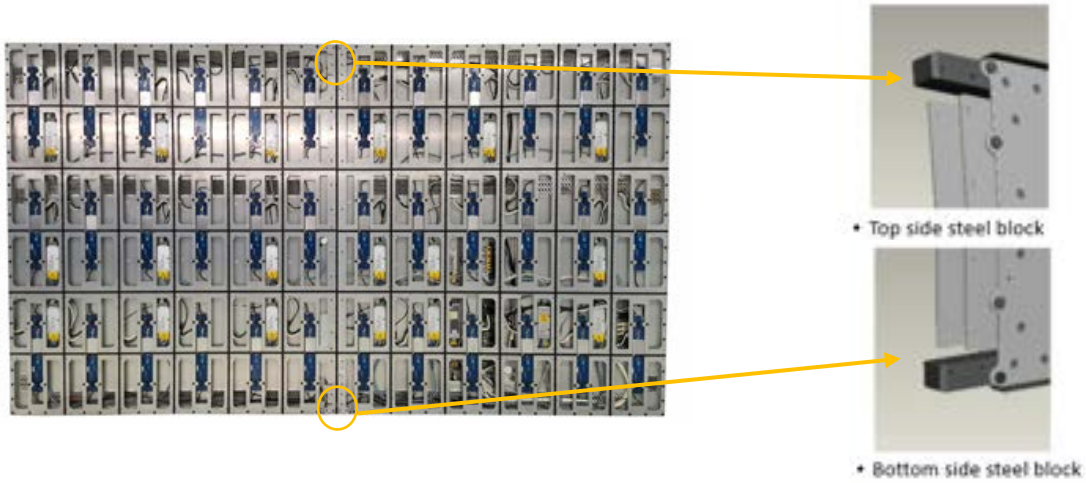

5. After the cabinet is joined, follow the instructions of Label to quickly fix the cabinet with the hexagonal plate.

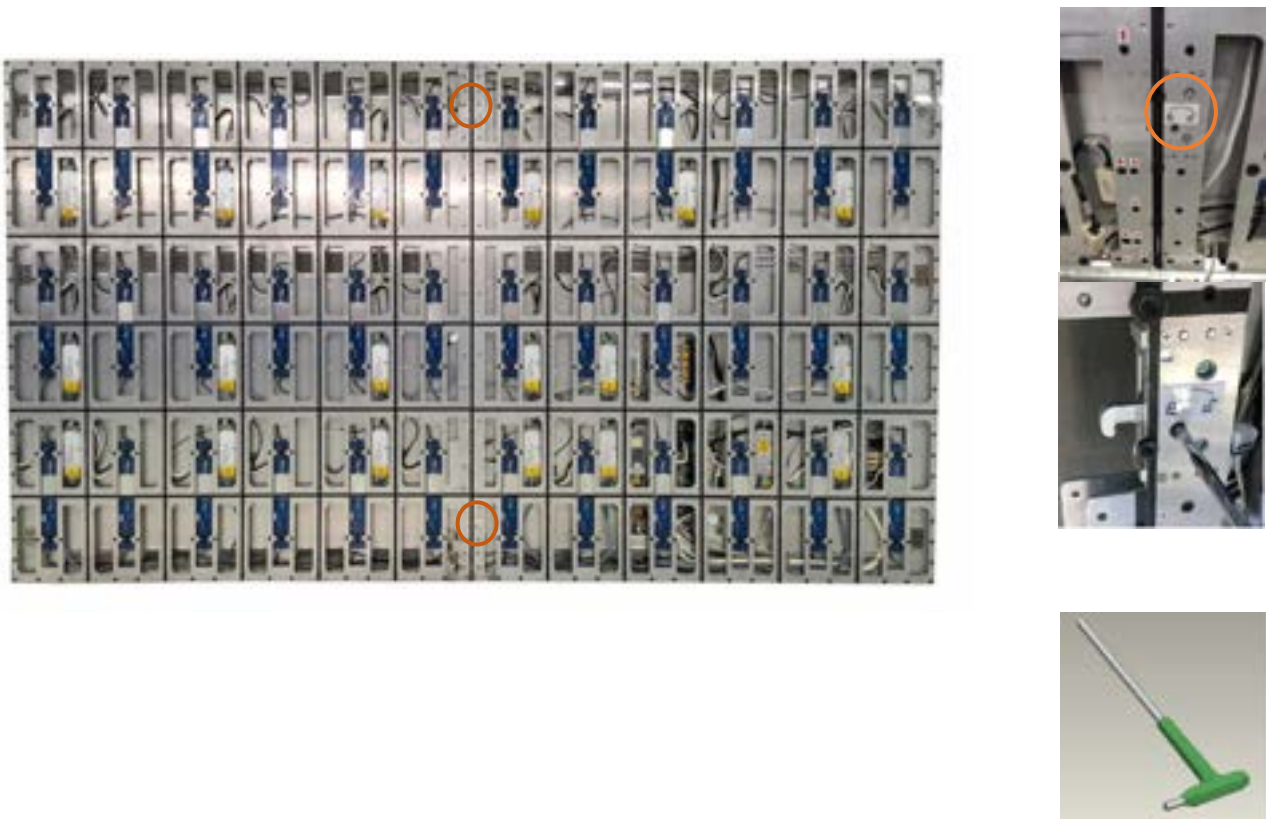



6. Install and tighten 8 pcs black M4 flat head screws to both top and bottom side of the case.

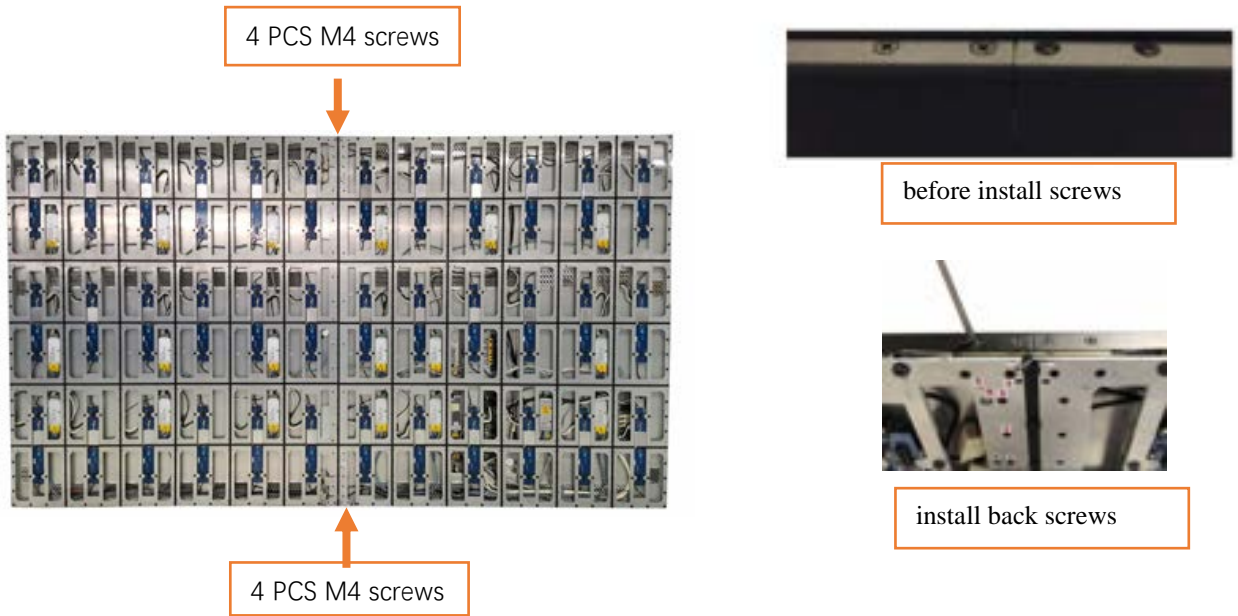

7. Install M4 screws.



Install 11 pcs fasten screws



Install 20 pcs M4 flat head screws

8. All the intelligent modules (LED Panel) have labels stuck on the back side. Please follow below number to install back the intelligent modules.

<u>01-01</u>	<u>01-02</u>	<u>01-03</u>	<u>01-04</u>	<u>01-05</u>	<u>01-06</u>	<u>01-07</u>	<u>01-08</u>	<u>01-09</u>	<u>01-10</u>	<u>01-11</u>	<u>01-12</u>
<u>02-01</u>	<u>02-02</u>	<u>02-03</u>	<u>02-04</u>	<u>02-05</u>	<u>02-06</u>	<u>02-07</u>	<u>02-08</u>	<u>02-09</u>	<u>02-10</u>	<u>02-11</u>	<u>02-12</u>
<u>03-01</u>	<u>03-02</u>	<u>03-03</u>	<u>03-04</u>	<u>03-05</u>	<u>03-06</u>	<u>03-07</u>	<u>03-08</u>	<u>03-09</u>	<u>03-10</u>	<u>03-11</u>	<u>03-12</u>
<u>04-01</u>	<u>04-02</u>	<u>04-03</u>	<u>04-04</u>	<u>04-05</u>	<u>04-06</u>	<u>04-07</u>	<u>04-08</u>	<u>04-09</u>	<u>04-10</u>	<u>04-11</u>	<u>04-12</u>
<u>05-01</u>	<u>05-02</u>	<u>05-03</u>	<u>05-04</u>	<u>05-05</u>	<u>05-06</u>	<u>05-07</u>	<u>05-08</u>	<u>05-09</u>	<u>05-10</u>	<u>05-11</u>	<u>05-12</u>
<u>06-01</u>	<u>06-02</u>	<u>06-03</u>	<u>06-04</u>	<u>06-05</u>	<u>06-06</u>	<u>06-07</u>	<u>06-08</u>	<u>06-09</u>	<u>06-10</u>	<u>06-11</u>	<u>06-12</u>

Front view

### Install the Sensor Box

1. Take out a sensor box. Run the cable through the hole on the back side.



2. Connect the cable to the convertor board. Align the sensor box to the panel and tighten it with two screws.

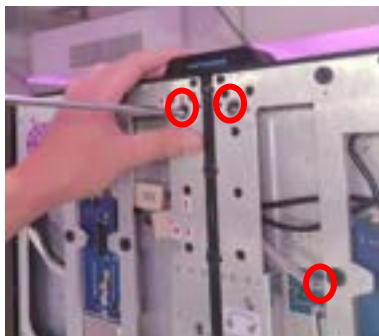

## Dismount Intelligent Module

Step1. Power off the LED display.

Step2. Hold the 2pcs handles, push the lock inward and pull the handles toward outside, and then take it up.

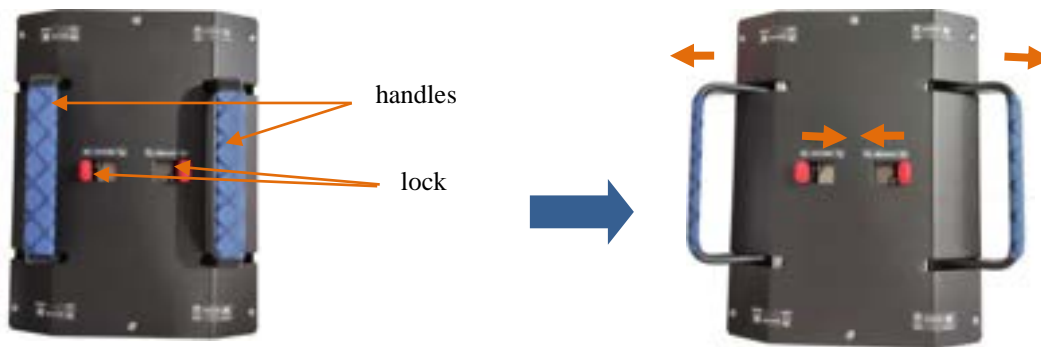

Step3. Take the tool up and horizontally fit it closely to the display surface. Please pay more attention to the direction.



Step4. Pull the handles towards the centre.



Step5. Ensure the magnet is locked. Detach the tile carefully.

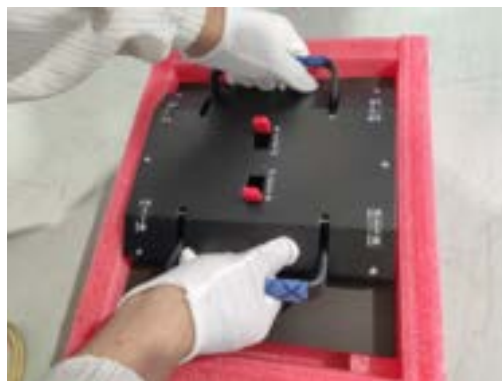

Step6. Put down the intelligent module and tool together carefully onto an EPE (or other soft pad).  
Step7. Push the lock toward inside and pull the right handle toward outside and lift the tool up carefully.

### Mount Intelligent Module

Step1. Take out a spare intelligent module and locate the intelligent module to case, please pay attention to the arrow direction on the back side of it.



Step2. Flatten the intelligent module.



**Note: When mounting an intelligent module back, pay more attention to the guide pin which is located in corners to mount it smoothly.**

9. We recommend that all the intelligent modules are installed to the corresponding position on case, or the screen will show color difference. Also, there is a panel serial number at the left bottom of case which match to the one on the back side of intelligent modules and spare intelligent modules.

## Packaging

**NOTE: The pictures are schematic diagrams. Everything is subject to the infact products.**



**Carton**

### I. Pack up the IMs.

Pack up six intelligent modules into an antistatic bag separately and set them into the foam box. (Pack up all the intelligent modules in this way.)



6 pcs IM



2. Pack up the mounting plate.



3. Pack up the cabinet and put them into the carton.



## 3.2 Electrical

The power distribution system used must provide adequate protection against excess line current and leakage currents to earth.

Electrical Characteristics for ONE A136-15-OB							
At 100V AC Input				At 240V AC Input			
Parameter	Unit	Rating nom.	Max.	Parameter	Unit	Rating nom.	Max.
Input current	A	12	30	Input current	A	5.00	12.5
Input freq.	Hz	50 – 60	65	Input freq.	Hz	50 – 60	65
Power	W	1200	3000	Power	W	1200	3000

### 3.2.1 Circuit Protection

Each section of the screen should be protected by a Circuit Breaker to protect against high fault currents, and a Residual Current Device (RCD) to detect earth leakage currents.

### 3.2.2 Earth Leakage Considerations

Each panel of the system has earth leakage current contributions from ten switched-mode power supplies and one SCHAFFNER/RFI filter. The total earth leakage current per panel can be up to 5.75mA at 240V. If a 30mA RCD is used, then the maximum number of panels per section should be safely limited to 5.

### 3.2.3 Inrush-current and Over-current Considerations

The inrush current of the switched mode power supplies used to provide LED and logic power to each panel is specified by the manufacturer as 97.5A at 115volts and 195A at 230volts for duration of 3ms. However, maximum current in the steady-state for a panel is considerably less: 12.5A at 240 volts and 30A at 100 volts. The circuit breaker used to control a section of the screen must be able to handle the short-term inrush current at switch-on, without causing unnecessary disconnection of the supply, and be able to detect excess currents due to faults within the equipment, during normal operation.

### 3.2.4 Earthing

Each panel is separately connected to the AC power distribution system's earth through the appliance coupler. All exposed panel metalwork (main frame) is also connected to this earth.

If the framework is earthed only through each panel (i.e. through the panel's mounting bolts), there is a possibility of electrical damage if a wiring fault occurs, or if an electrical discharge, such as lightning strike, hits the panels. Under these circumstances, the current discharge path will be through the panel to earth rather than through the framework to earth. When permanently installed on a metal framework, the framework itself should be directly connected to earth also.

### 3.2.5 EMC Statement

Installations should be located at least 30 meters from other sensitive systems or installations and if situated in close proximity to a roadway it may create interference to vehicle radio communications.

### 3.2.6 FCC Statement

This equipment has been tested and found to comply with the limits for a Class A digital device, pursuant to Part 15 of the FCC Rules. These limits are designed to provide reasonable protection against harmful interference when the equipment is operated in a commercial environment. This equipment generates, uses, and can radiate radio frequency energy and, if not installed and used in accordance with the instruction manual, may cause harmful interference to radio communications. Operation of this equipment in a residential area is likely to cause harmful interference in which case the user will be required to correct the interference at his own expense.

\*Note: Modifications not authorized by the manufacturer may void users authority to operate this device.

### 3.3 Power Cable Wiring

#### 3.3.1 AC Power

An approved three-pole appliance coupler inside the panel connects to the AC supply. The AC power cable is then connected to the EMI filter and distributes to the power supply units. Each panel has an earth point for grounding.

Colour of Wire	A.C. Supply connection (for 100V)	A.C. Supply connection (for 240V)
Brown	AC. Live	AC. Live
Blue	AC. Neutral	AC. Neutral
Green/Yellow	AC. Protective earth	AC. Protective earth

#### 3.3.2 Number of Power Cords

- 1) Countries using 110V AC : The product contains two input power supply cords intended for connection with two independent AC power source.
- 2) Countries using 220V AC : The product contains one input power supply cord intended for connection with one independent AC power source.

#### 3.3.3 DC Power

DC power from each power supply unit provides low voltage power to the assigned electronics components, for example, driver board, and fans, the responding color of the wire represents the relevant component's power connection, please note the list below for a clear cabling configuration.

Colour of wire	D.C. Supply connection
White	Green LED / Blue LED / Red LED /TTL
Black	GND



## 4. Setting

### 4.1 The Introduction of A136-15-OB Screen Interface and Function

#### 4.1.1 Remote Controller



#### 4.1.2 Interface Specifications

**NOTE:** The volume buttons are not placed on the cabinet. It can only be controlled by the remote controller.

Item	Port	In/Out	Spec and function	LAEB015-GN
1,2	Indicator		Standby/running	√
3	Standby switch		Startup/power off	√
4,5	Br+/Br-		Screen brightness adjustment	√
6	Source Switch		Source switching	√
7	Sender control		Parameter setup/program release	√
8,9,10	USB		Access media content, firmware update	√
11,12,13	HDMI	IN		√
14	Audio	Out	Support LINEOUT	√
15	IR	IN		√
16	LAN		Disabled Reserved for future use	

### 4.1.3 Connection

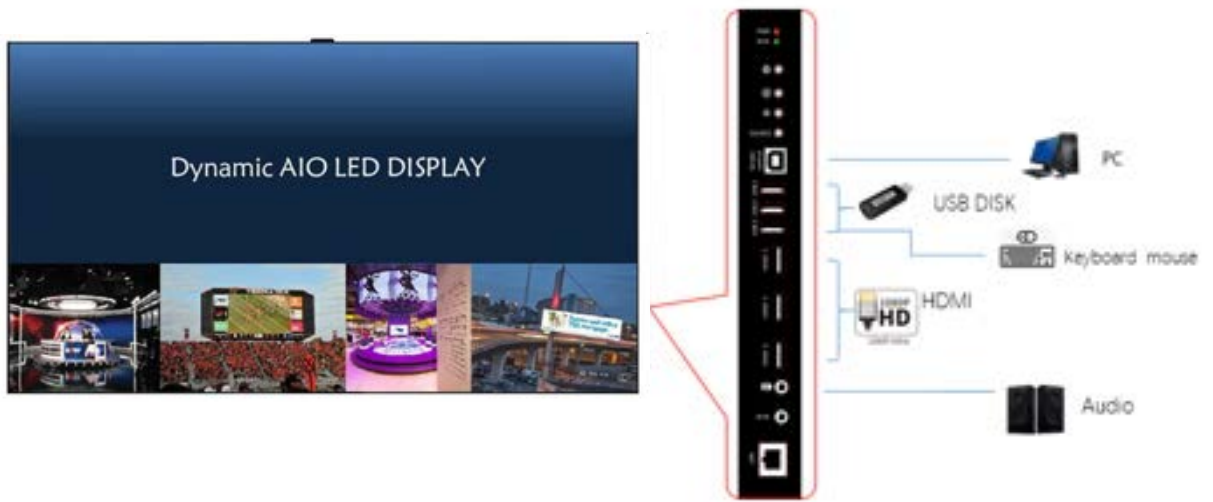

## 4.2 Parameter Settings

### 4.2.1 Set Up the Connection

Turn on the power of the screen, use the standard USB cable to connect the computer with the screen, open the software, [Control] -> [LED Screen Settings] -> [Sending device] -> [Sender], click [Detect Senders]. If detect the product model, it means the connection is successful.

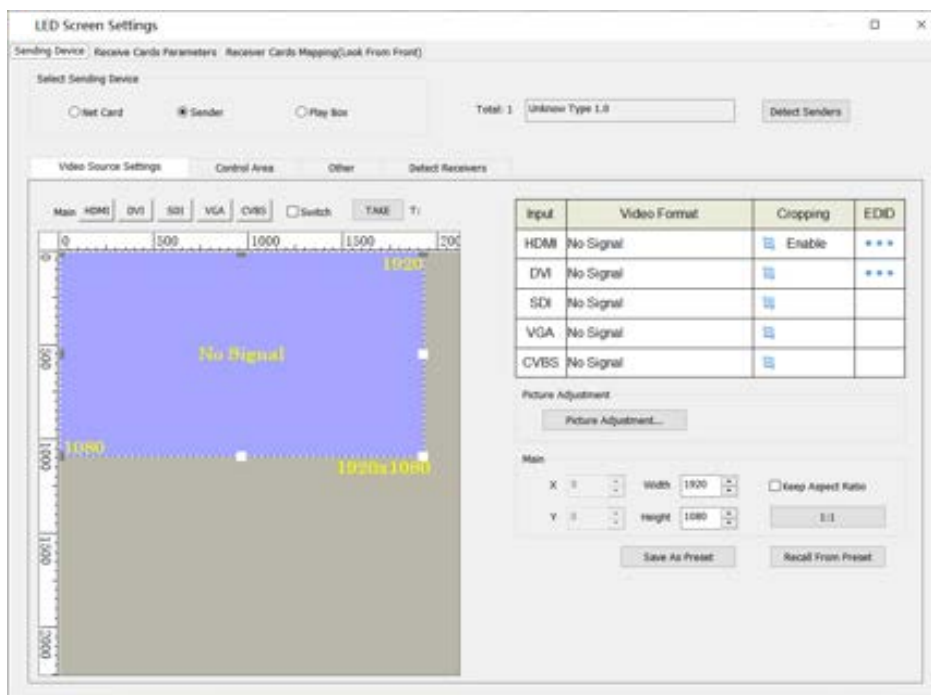
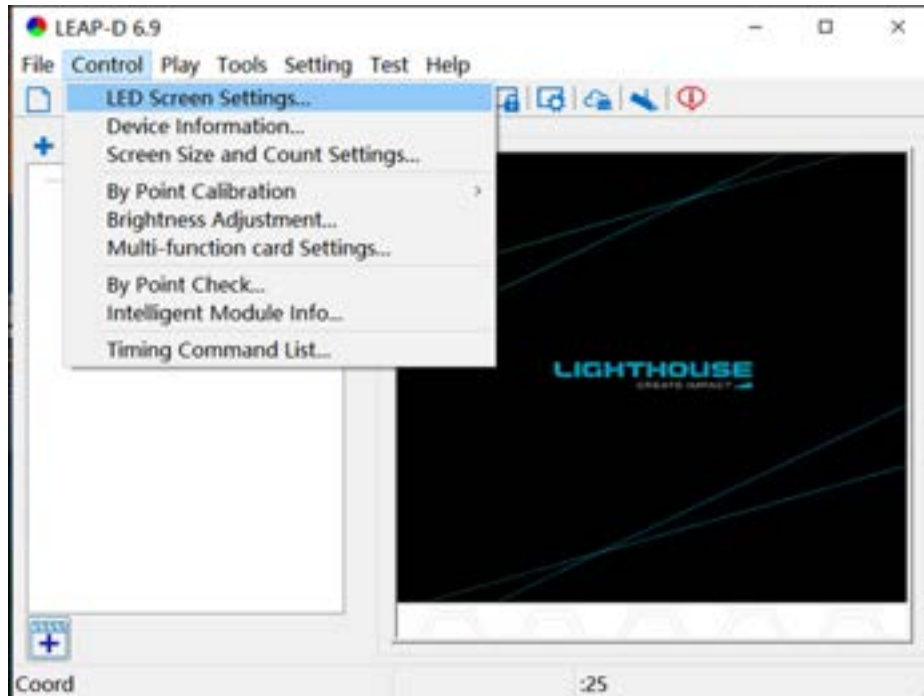

## 4.2.2 Basic Setup

Make sure the LED display is properly debugged before setting screen parameters.

When setting screen parameters, use the standard USB cable to connect the PC and control the LED display through the gigabit network port.

## 4.2.3 Parameter Settings

Connect the PC to the display screen successfully, the screen parameter information will show in the sending card.

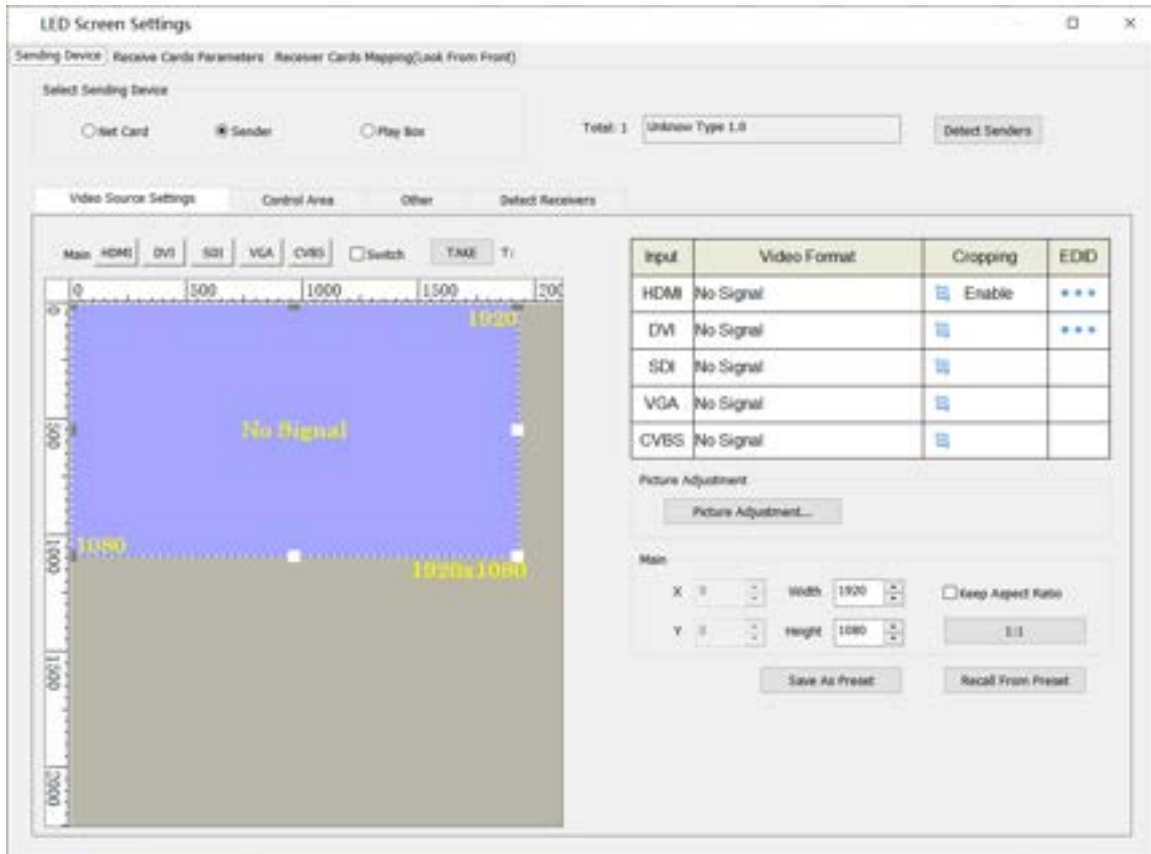

## 4.2.4 Video Source Settings

Interface connection mode:HDMI1, HDMI2, HDMI3, internal media.

Input format is displayed according to HDMI and internal media source screen resolution.

Clipping, which can be used to zoom out the input signal source screen.

Input	Video Format	Crop	EDID
HDMI1	No Signal		...
HDMI2	No Signal		...
HDMI3	1920x1080@59.9HzRGB	Enable	...
Internal Media	1920x1080@60HzRGB		

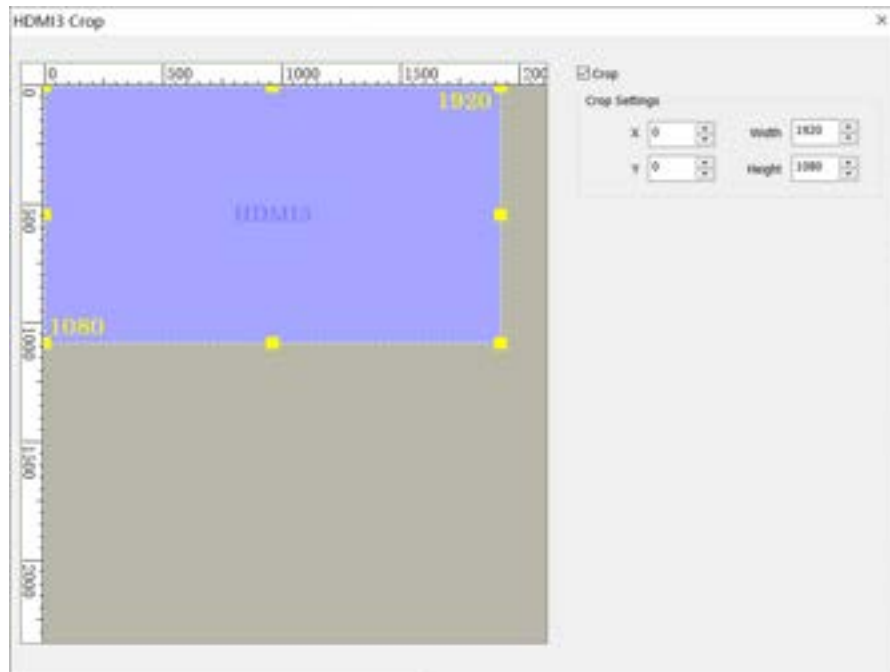

The resolution can be adjusted with EDID function when using HDMI input picture.

Output mode can be set to the main screen, PIP1, PIP2, at most, the main screen and PIP1, PIP2 can be displayed at the same time.

Screen adjustment can adjust the color, saturation, brightness compensation and contrast of HDMI input and internal media output (as shown in the below picture).

The width and height of the home screen can be set to 1920x1080.

The resolution of the main screen can be modified. After the resolution is modified, power off and restart can take effect.

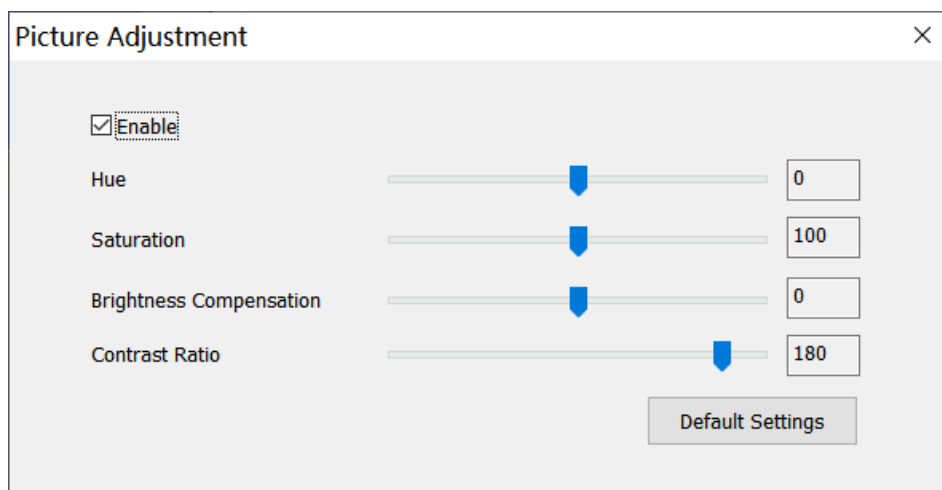

#### 4.2.5 Others

Advanced parameters - low light high ash can be used, connections from the sending card.  
The parameters of the software adjustment can be imported or exported.  
All parameters become default after factory Settings are restored.

#### 4.2.6 Detect the Receiver Card

On the right is the statistics of the receiver card loaded on the network port, and on the left is the detailed information of the receiver card. Click [Detect All Receivers] to refresh the current load condition.

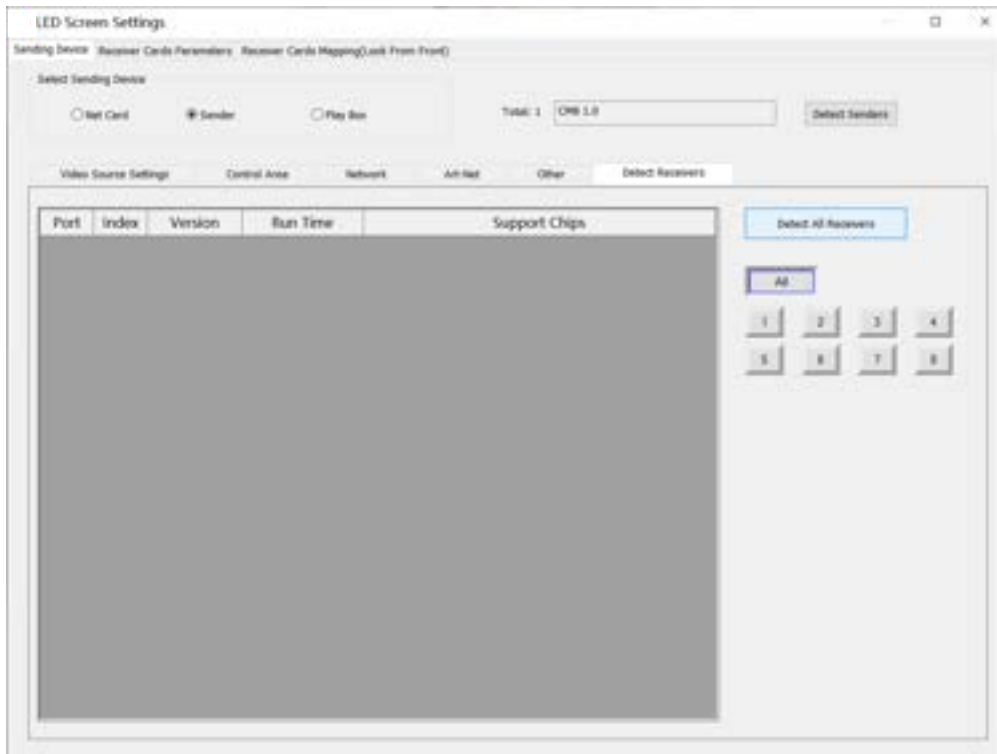

## Appendix A Procedure for IM Replacement

When you find the IM is malfunctioning, you can replace it with the following procedure:

1. Power off the panel and unplug the power cable;
2. Locate the problem IM;
3. Remove all the cabling (from the power connector and data connector, see Figure 2.3) of the problem IM.
4. Loosen the screws of the problem IM and take the IM off from the panel;
5. Mount the IM back to the same position as the problem one;
6. Make sure the IM is firmly mounted, as which will affect the water resistance ability of the front panel;
7. Power on the panel;
8. Please make sure the replaced IM is functioning well.

## Appendix B Trouble Shooting Guide

### I. Network connection problems:

If the main network line to the last abnormal module is not bright, the main network line is connected abnormally, and the abnormal module outputs an abnormal network line.

Inspection: Recheck the state of the network cable in the corresponding position to confirm that the connection is OK.



If the abnormal module to the backup network port cable is not bright, the abnormal module input abnormal, and backup network cable connection abnormal.

Inspection: Recheck the state of the network cable in the corresponding position to confirm that the connection is OK.



## 2. IMs problems:

The abnormal module position of IM is abnormal.

Inspection: Replace the IM in the corresponding position.



## 3. PSU problems:

The abnormal module position of IM is not bright, the state of the PSU in the corresponding position is power supply abnormally.

Inspection: Replace the PSU in the corresponding position.



## 4. The adapter board problems:

The abnormal module position of IM is not bright, the state of the adapter board in the corresponding position is work abnormally.

Inspection: Replace the adapter board in the corresponding position.

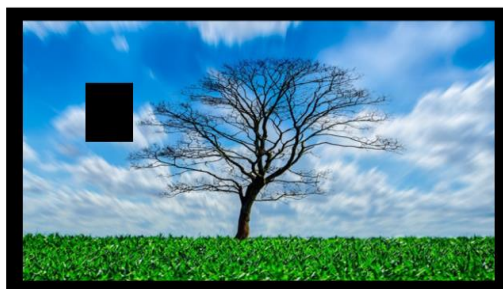



## 5. The receiver board problems:

The abnormal module position of IM is not bright, the state of the receiver board in the corresponding position is work abnormally.

Inspection: Replace the receiver board in the corresponding position. And resends the receiver card parameter to all receiver cards or sends to the specified receiver card.



## 6. The calibration data is abnormal:

Some IMs are particularly bright when the screen is white, unlike others.

Inspection: Switch calibration off again, then switch to calibration on to confirm the existence of calibration data.

You can also switch IMs data and receiver card data to confirm that the calibration data exists and is correct. If none of the above is feasible, the corresponding calibration data needs to be reloaded and resend.



## 7. The whole screen doesn't light up:

It may be caused by abnormal power supply and internal power board.

Inspection: Check to make sure the power supply and the power board are in order.

If the signal source is switched without a black screen, confirm that the input source is normal, the signal line is normal, and the signal transfer board is working normally.

**Appendix C A136-15-OB Mechanical Assembly**

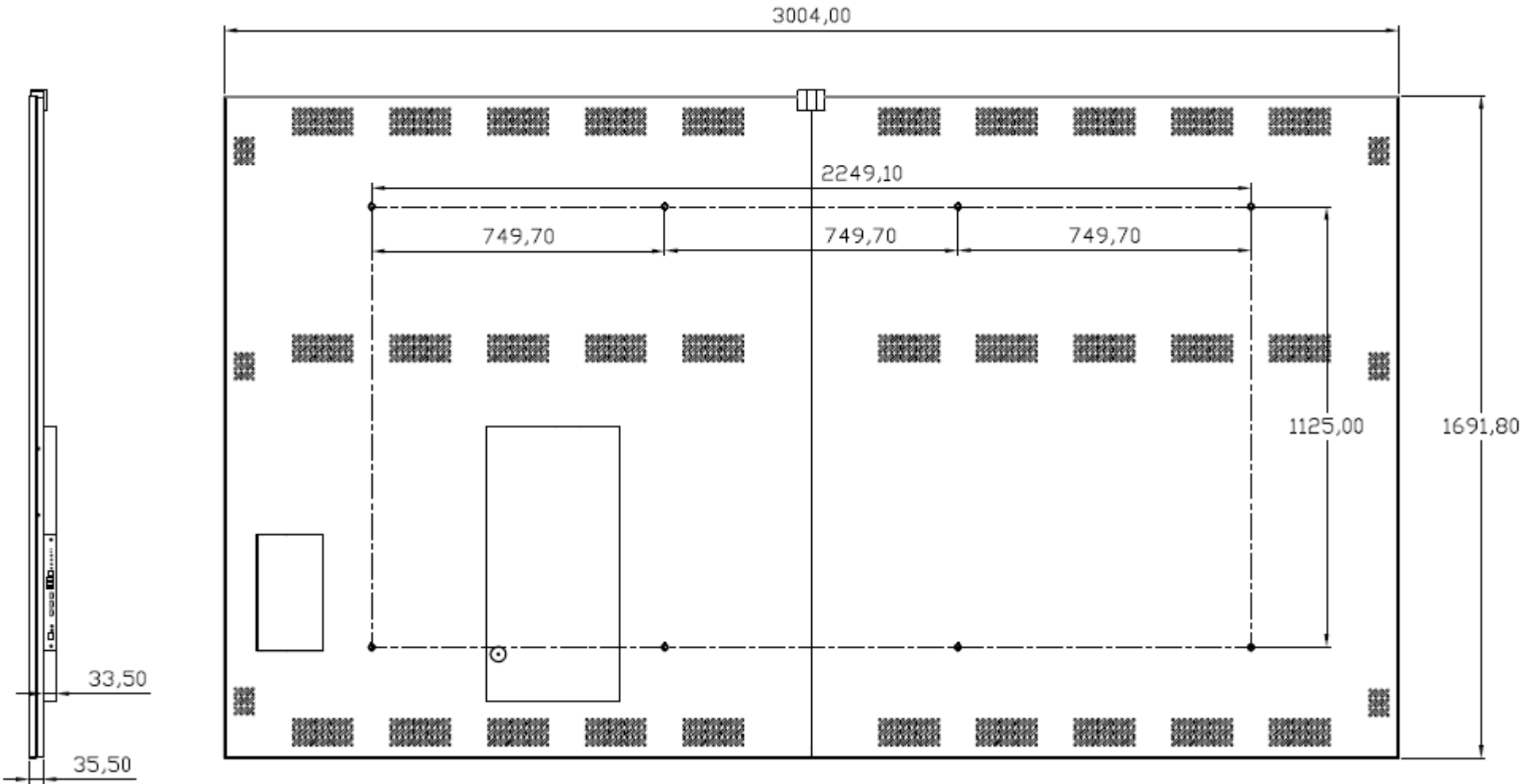

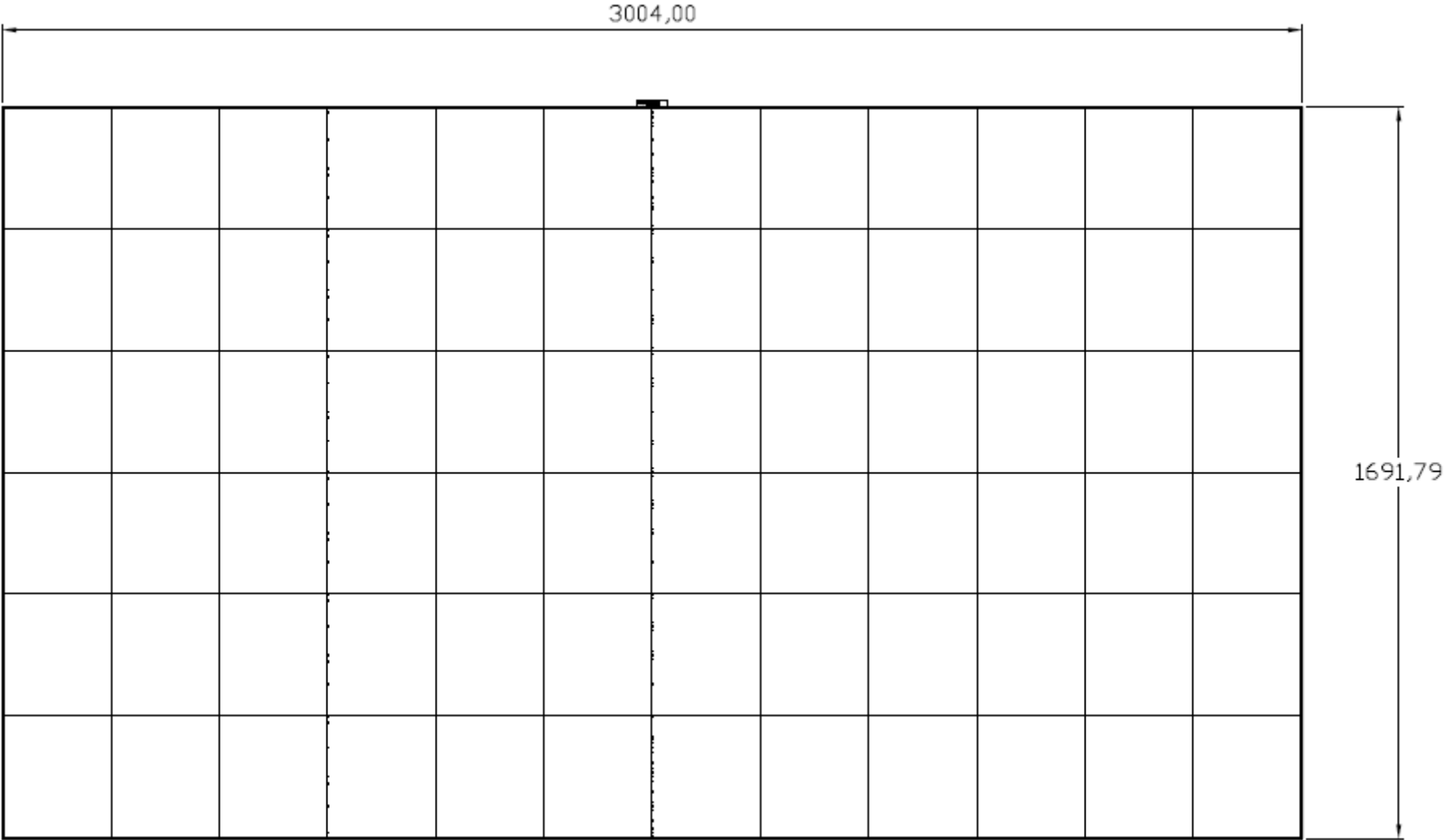

**Appendix D A136-15-OB Data Wiring Diagram**

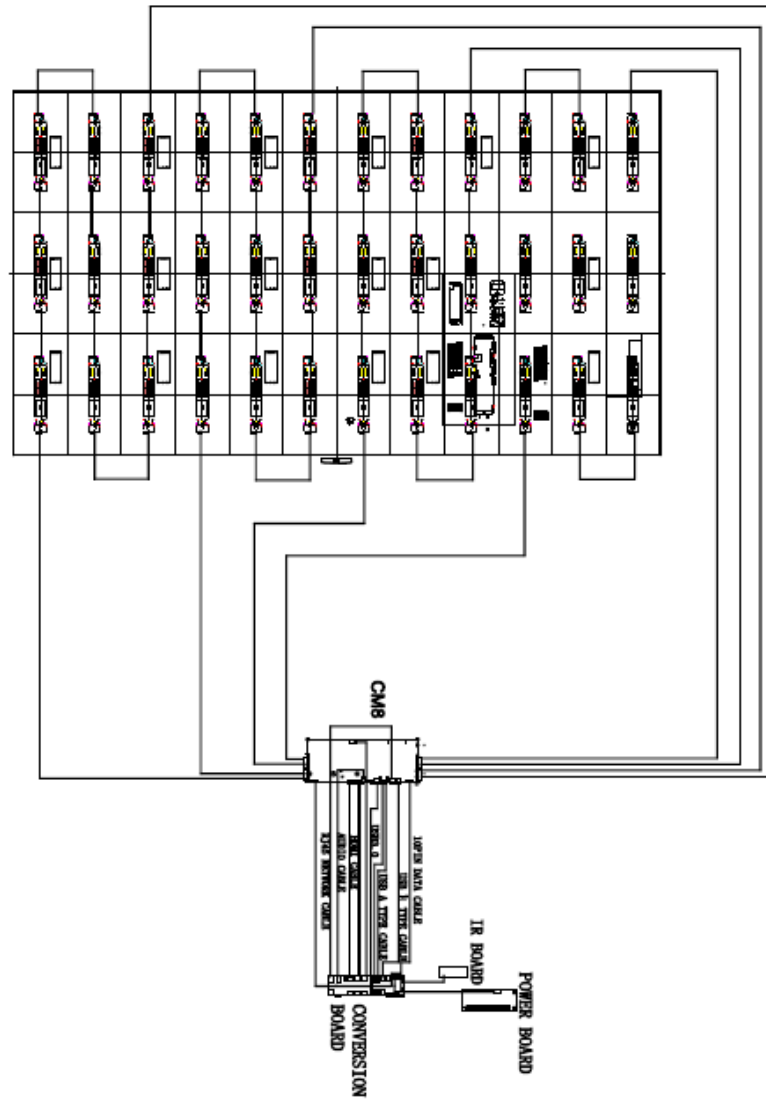

**Appendix E AI36-15-OB Power Wiring Diagram**

